

Specifications

Nominal Voltage	12v
Nominal Capacity (20 Hr)	35AH
Length	195mm
Width	130mm
Height	164mm
Total Height	178mm
Weight	11.2Kg
Max Discharge Current	525A (5 Sec)
Internal Resistance	11mΩ
Initial Charging Current	Less than 10.5A
Container Material	ABS resin
Rated Capacity (+/- 5%)	29.8 AH (5hr, 1.75V/cell, 25°C/77°F) 35 AH (20h, 1.75V/cell 25°C/77°F) 38.4 AH (100hr, 1.75V/cell, 25°C/77°F)
Operating temperature range	
Charge:	0~40°C (32~104°F)
Discharge:	-15~50°C (5~122°F)
Storage:	-15~40°C (5~104°F)
Charge retention (shelf life) at 20°C (68°F)	
1 month	97%
3 months	91%
6 months	85%

Dimensions

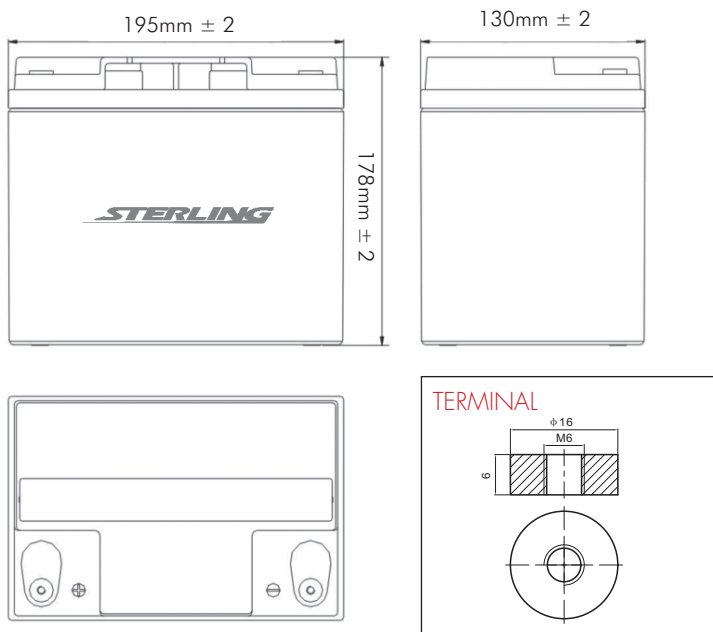

FEATURES

- Superb recovery from deep discharge.
- Gas Recombination.
- Multipurpose: Float or Cyclic use.
- Lead calcium grids for extended life.

Sealed Construction

Sterling's unique construction and sealing technique ensures no electrolyte leakage from case or terminals.

Electrolyte Suspension System

All HP series batteries utilise Sterling's unique electrolyte suspension system incorporating a microfiber glass mat to retain the maximum amount of electrolyte in the cells. The electrolyte is retained in the separator material and there is no free electrolyte to escape from the cells.

Control of Gas Generation

The design of HP series batteries incorporates the very latest oxygen recombination technology to effectively control the generation of gas during normal use.

Terminals

Sterling's HP series batteries are manufactured using a range of terminals which vary in size and type. Please see diagram opposite.

Valve Regulated Design

The batteries are equipped with a simple, safe low pressure venting system which releases excess gas and automatically reseals should there be a build up of gas within the battery due to severe overcharge. Note. On no account should the battery be charged in a sealed container.

Charging and Discharging Information

Discharge characteristics

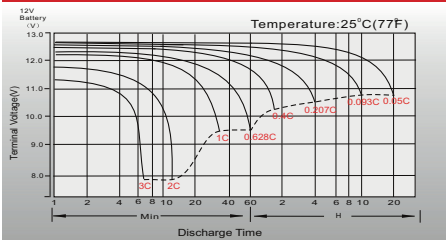

Float charging characteristics

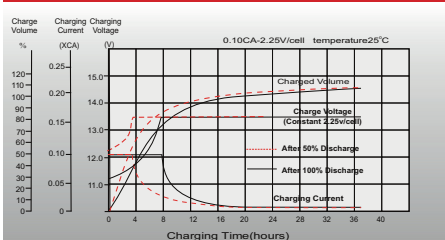

Temperature effects in relation to battery capacity

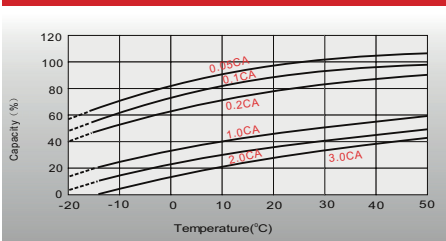

Effect of temperature on long term float life

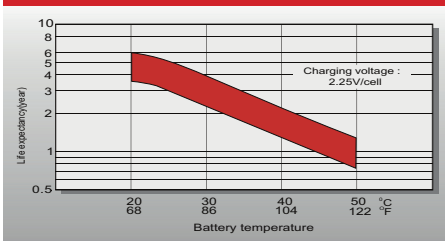

Cycle life in relation to depth of discharge

Testing condition

Discharging: current 0.17C (FV 1.93V/cell);
Charging: current 0.25C max, voltage 2.45V/cell;
Charging volume: 125% of discharged capacity.

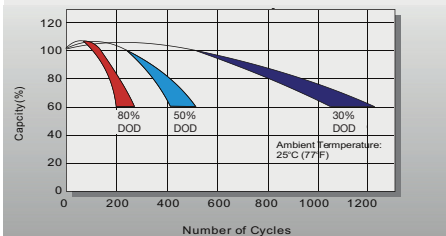

Self discharge characteristics

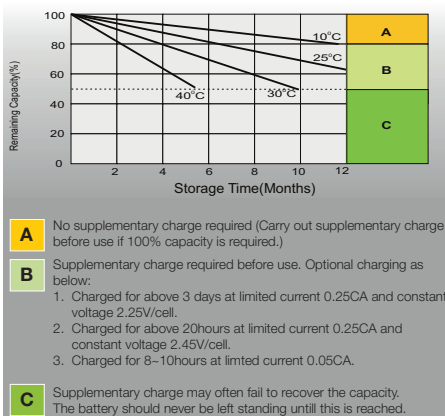

- A** No supplementary charge required (Carry out supplementary charge before use if 100% capacity is required.)
- B** Supplementary charge required before use. Optional charging as below:
 1. Charged for above 3 days at limited current 0.25CA and constant voltage 2.25V/cell.
 2. Charged for above 20hours at limited current 0.25CA and constant voltage 2.45V/cell.
 3. Charged for 8-10hours at limited current 0.05CA.
- C** Supplementary charge may often fail to recover the capacity. The battery should never be left standing until this is reached.

Charging (25°C/77°F)

Standby use: Float charging voltage 13.5V to 13.8V. (Temperature compensation recommended)

Cyclic use: maximum charging current (see front page). Charging voltage 14.4V - 15V.

Top charge: Product in storage (ambient temperature) required a top charge every 6 months at 25°C (77°F). For higher temperatures, time intervals will be shorter.

Discharge

Stop operation when voltage has reached the minimum permissible voltage; recharge immediately.

Storage

Always store battery in fully charged condition. Store batteries in a dry and cool location.

Temperature

For standby use, batteries should be kept in an ambient temperature of 25°C.

Caution

- Do not short circuit
- Do not charge in a sealed container
- Service life and operational characteristics will be effected by temperature
- AC ripple reduces service life

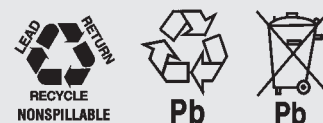

Applications

- Renewable Energy • Marine • Uninterruptable Power Supply (UPS) • Electric Power System (EPS)
- Emergency Lighting • Railway/Aircraft Signal • Alarm & Security System • Electronic Equipment
- Communication Power Supply • DC Power Supply